



TM

Timberkits

**Double Bass
Player**

CE 

(UK) Symbols in these instructions. (FR) Symboles des instructions. (ESP) Símbolos en estas instrucciones. (IT) Simboli in queste istruzioni. (Ger) Symbole in dieser anleitung



(UK) Waiting time.
(FR) Temps d'attente.
(ESP) Tiempo de espera.
(IT) Tempo d'attesa.
(DE) Wartezeit.



(UK) Wax surface to lubricate.
(FR) Appliquer la cire sur cette surface.
(ESP) Aplica la cera sobre esta superficie.
(IT) Applicare la cera su questa superficie
(DE) Wax Oberfläche zu schmieren.



(UK) Glue guard. Prevents glue getting between moving parts during build. Remove after 2 minutes.
(FR) Piece de protection contre la colle. pendant l'assemblage, eviter tout dépôt de colle sur les pieces en mouvement. Enlever apres 2 minutes.
(ESP) Parte de protection de el pegamento. durante la fase de esambalje, evitar que el pegamento se ponga sobre partes que se mueven. Quitar despues de dos minutos .
(IT) Pezzo di protezione della colla. Durante l'assemblaggio evitare che la colla vada su parti non statiche . Imuovere dopo due minuti.
(DE) Karton. Verhindert das eindringen von leim zwischen die bewegliche teile während der montage. Zwischen die beweglichen teile.



(UK) Glue.
(FR) Coller.
(ESP) Pegar.
(IT) Incollare.
(DE) Leimen



(UK) Don't glue.
(FR) Ne pas coller.
(ESP) No pegar.
(IT) Non incollare.
(DE) Nicht leimen.

Helpful hints/conseils utiles/consejos utiles/suggerimentutili/nützliche tipps

(UK) Check all parts present in trays
(FR) Vérifier que toutes les pièces soient présentes dans les bacs
(ESP) Controlar que hay todas la partes en la caja
(IT) Controllare tutte le parti presenti nel kit
(DE) Bitte prüfen sie, ob alle benötigten teile vorhanden sind

(UK) Read all instructions and look at all diagrams
(FR) Lire toutes les instructions et regarder toutes les figures
(ESP) Leer las intrucciones y guardar a los diagramas
(IT) Leggere tutte le istruzioni e guardare i diagrammi
(DE) Lesen sie alle anweisungen und betrachten sie die schaubilder

(UK) Check assembly before gluing
(FR) Vérifier le montage avant collage
(ESP) Controlar el montaje antes de empezar a pegar
(IT) Controllare l'assemblaggio prima di incollare
(DE) Montage prüfen vor dem einklebern

(UK) Some parts may need sanding
(FR) Certaines pièces nécessiteront d'être poncées.
(ESP) Algunas parte necesitan de ser suavizadas
(IT) Alcune parti potrebbero aver bisogno di levigatura
(DE) Möglicherweise müssen manche teile geschliffen werden

Colouring tips/conseils concernant l'application de peinture/ consejos para Pintar/ suggerimenti per colorare/ lackiertipps

(UK) Do not apply paint to parts which move against one another. It is easier to paint some parts before assembling
(FR) Ne pas appliquer de peinture sur les parties qui se déplacent l'une contre l'autre. Il est conseillé de peindre avant assemblage
(ESP) No aplique la pintura sobre las partes que se tocan. Resulta mas facil pintar las partes antes de montar.
(IT) Non applicare la pittura su quelle parti dove ce attrito con un'altra parte. è piu semplice pitturare alcune parti prima della fase di assemblaggio.
(DE) Teile, die aneinander reiben, sollten nicht lackiert werden. Fertig lackierte teile sind off leichter zu montieren

New Symbols in our Instructions



Visit our website to view instructional videos where you see this symbol.

www.timberkits.com



Pay special attention to this section.

Timberkits

NEED ADVICE?



Luise Willis - Model Expert

There's a Timberkit human
here to help!

Call: 01650 521635

Or visit our website for tips, advice and our
instructional videos.

www.timberkits.com

13

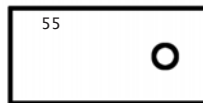
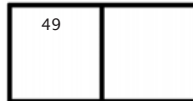
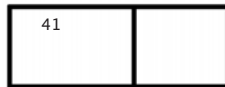
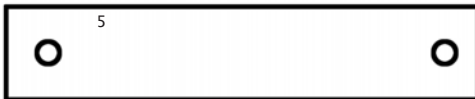
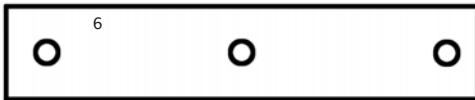
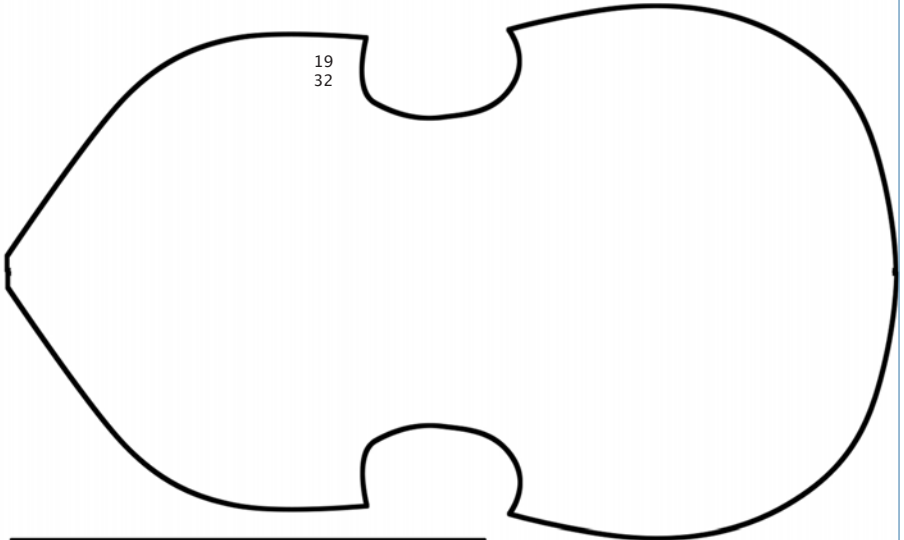
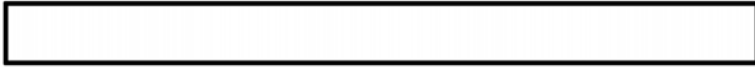

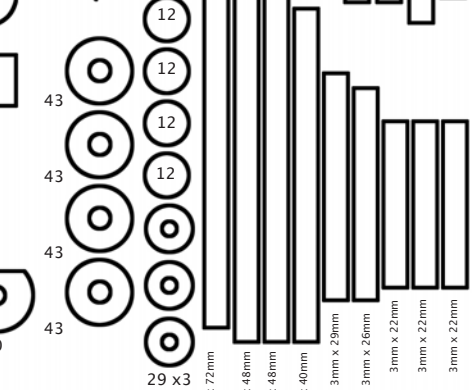
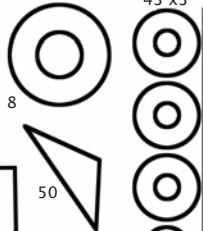
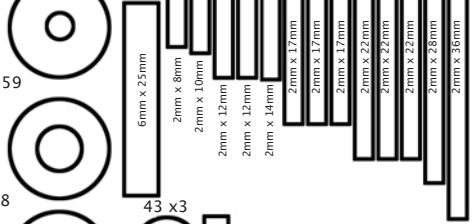
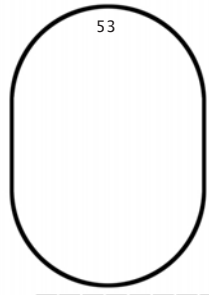
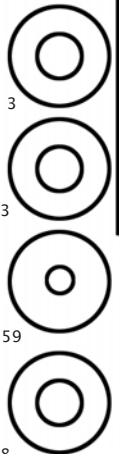
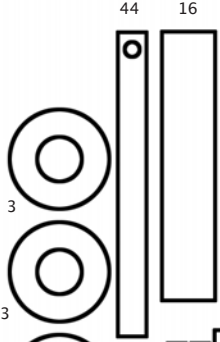
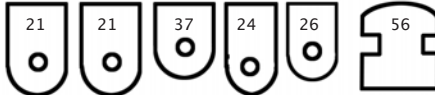
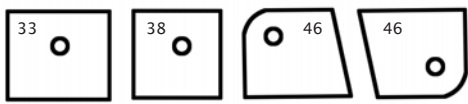
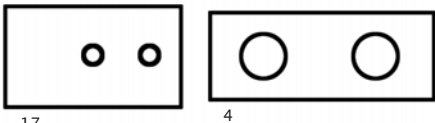
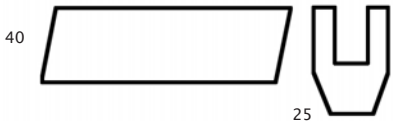
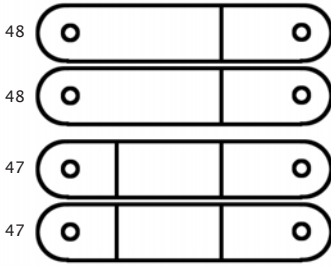
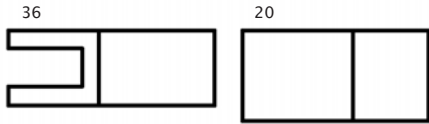

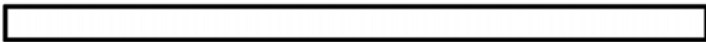
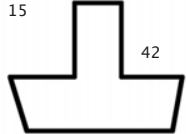
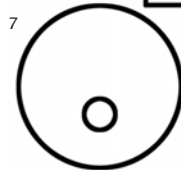
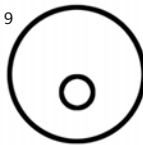
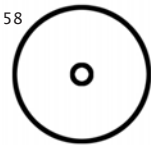
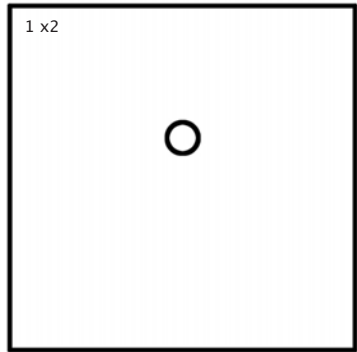
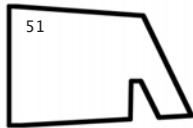
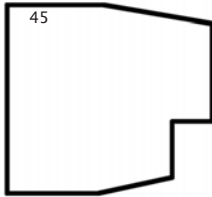
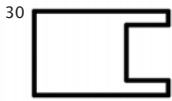
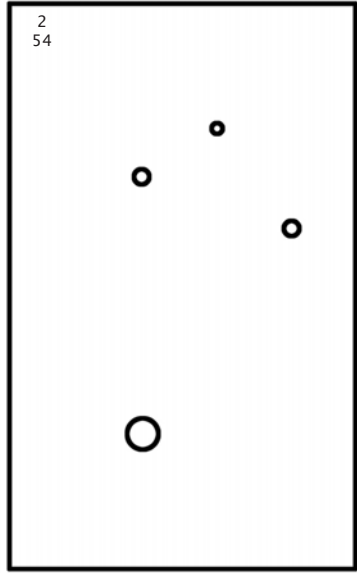
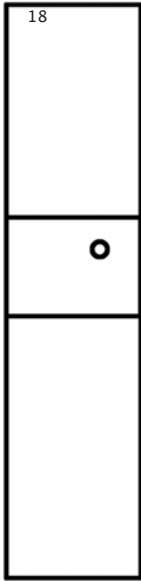

6mm x 132mm

1

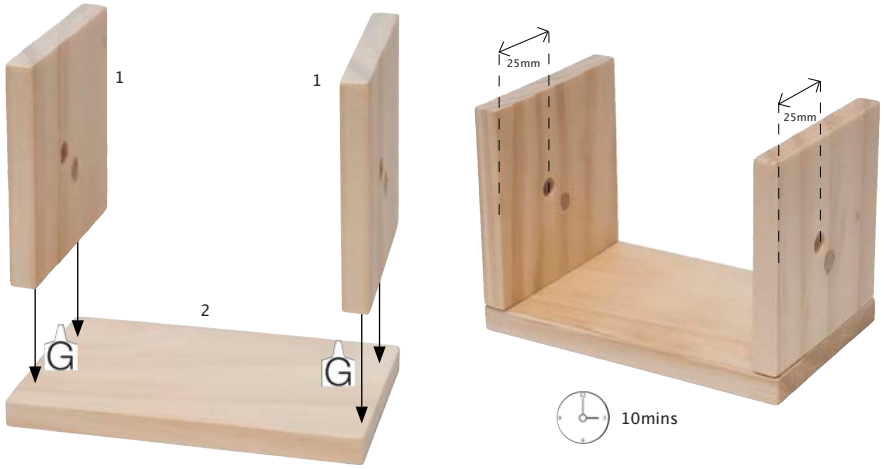

2

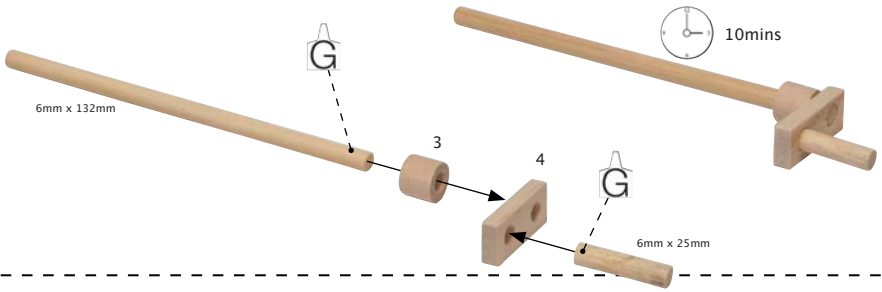

3

3a

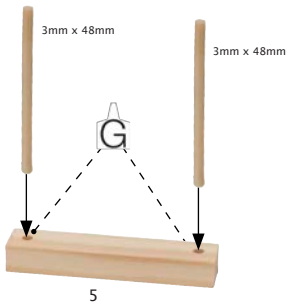

3b

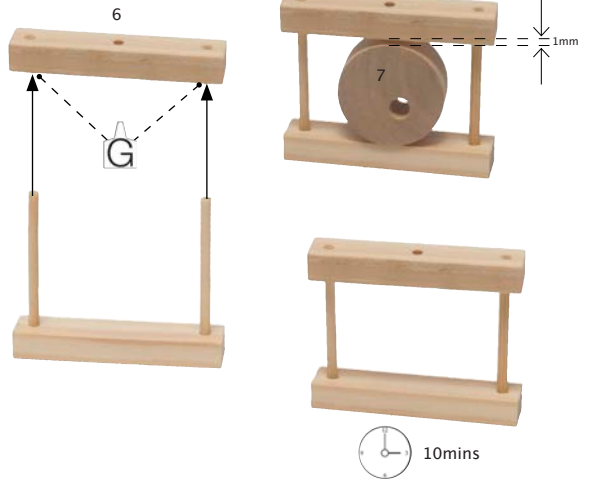

4

4a

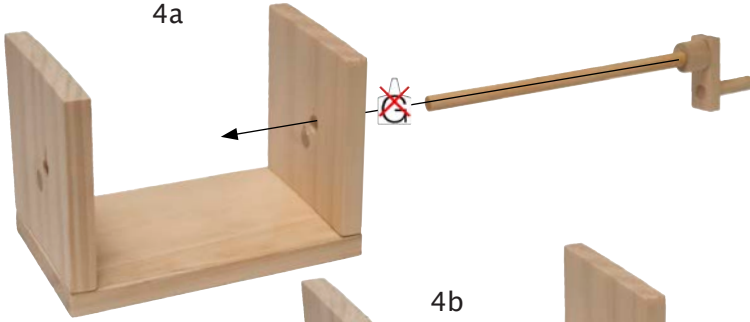

4b

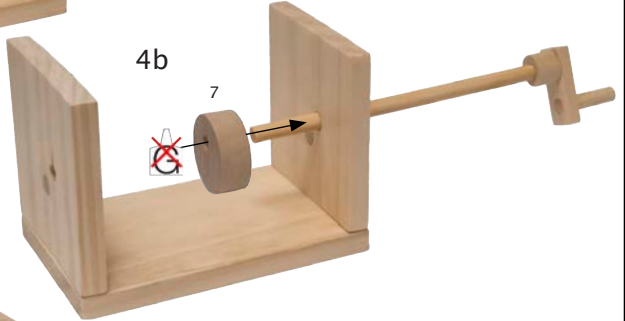

4c

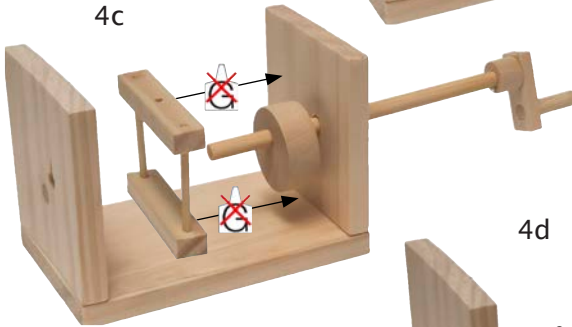

4d

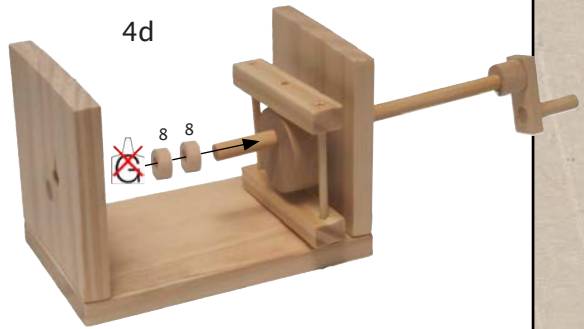

4e

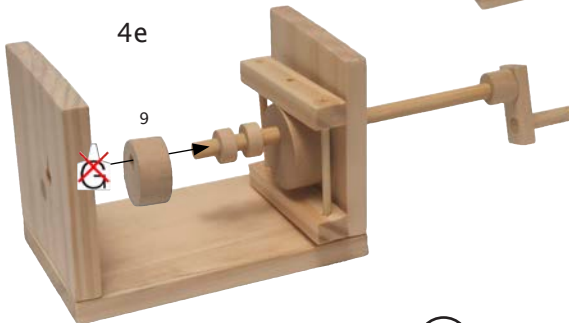

7

4 cont.

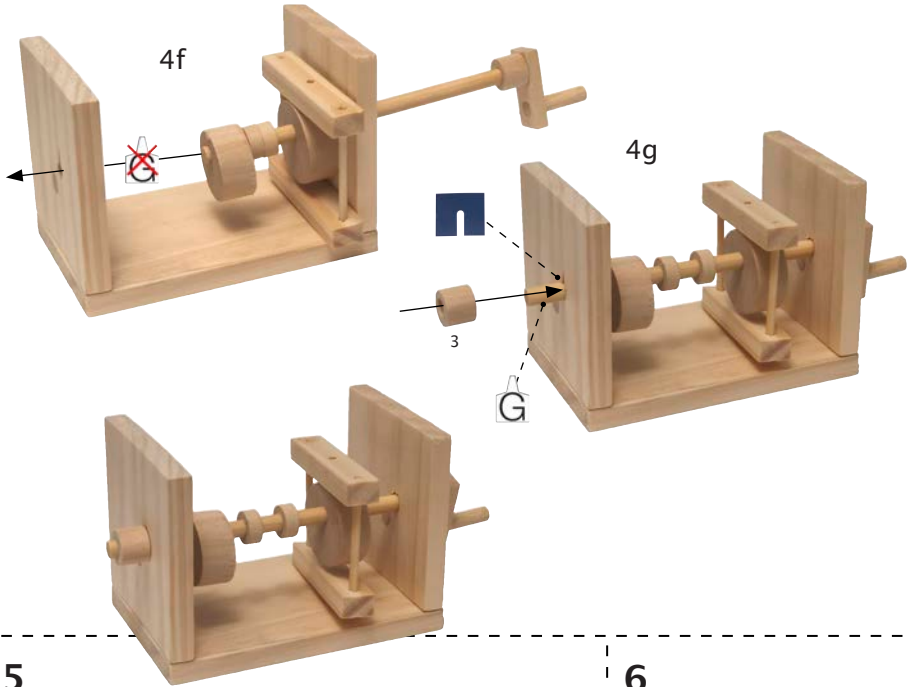

5

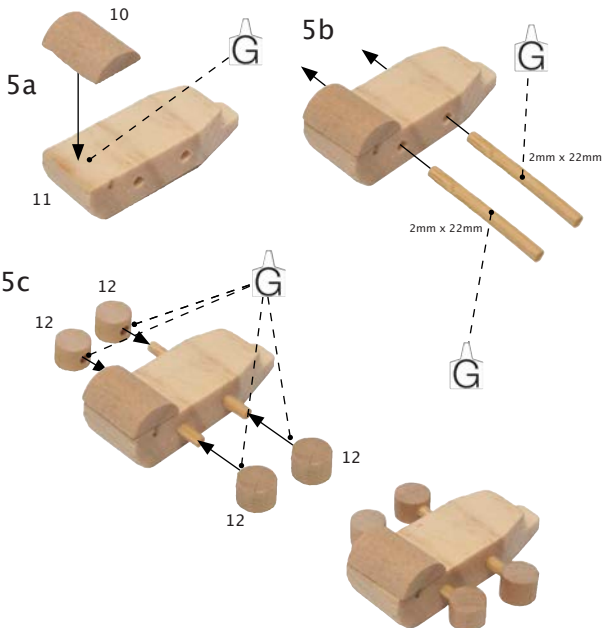

6

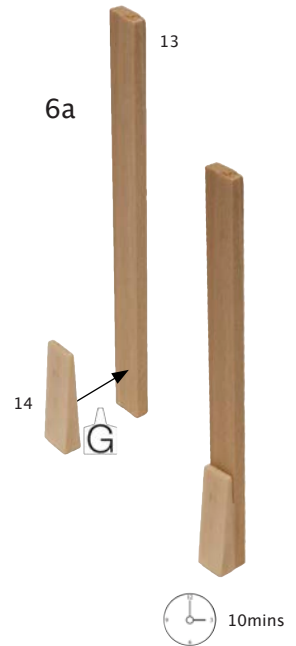

6 cont.

6b

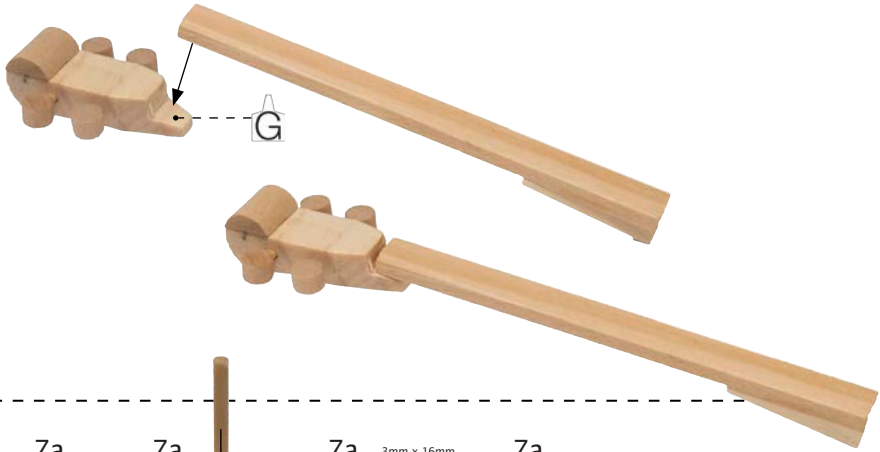

7

7a

7a

7a

7a



15

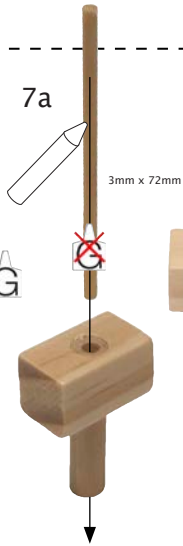

16

3mm x 72mm

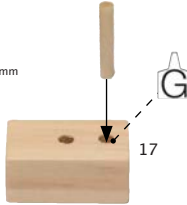

17

3mm x 16mm

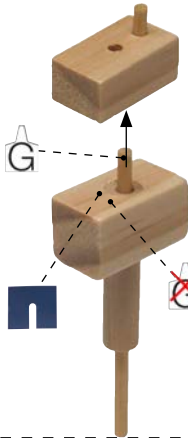

8

8a

8b

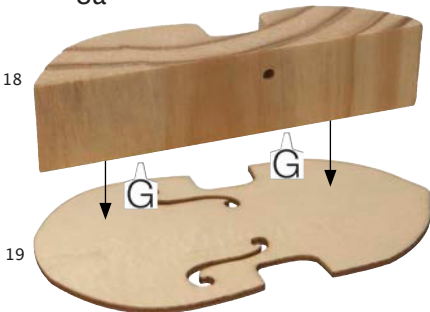

18

19

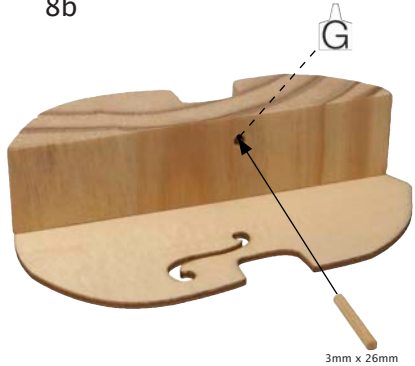

3mm x 26mm

7

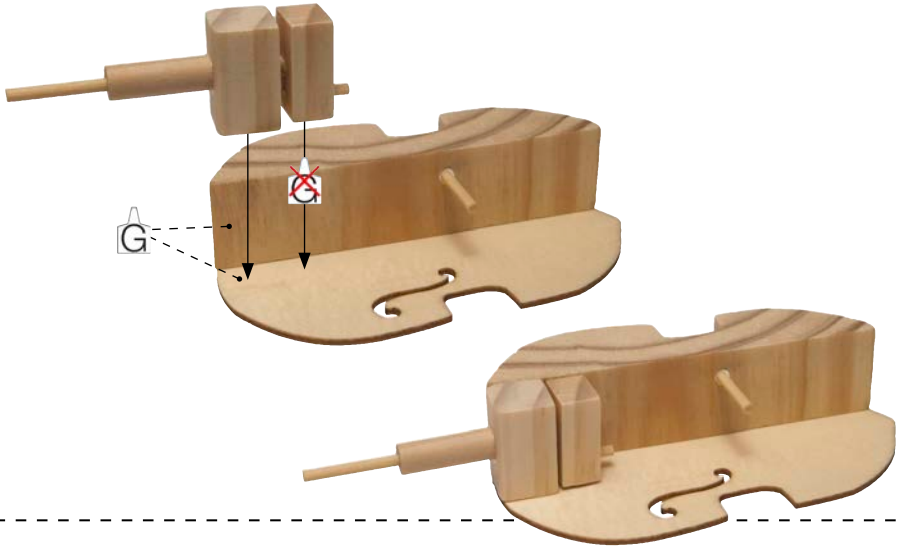

8

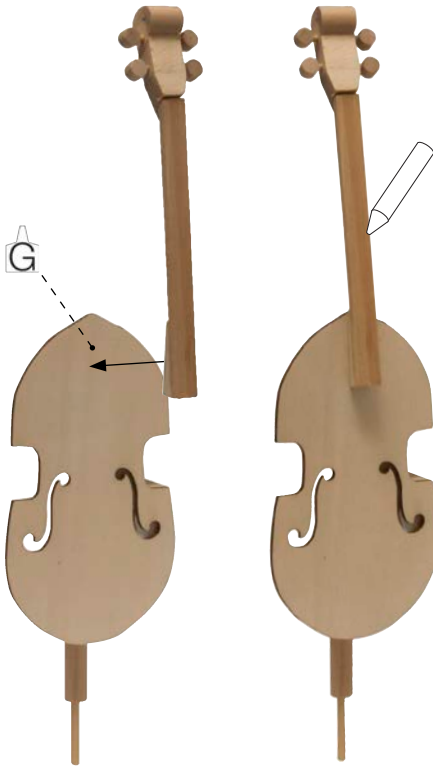

9

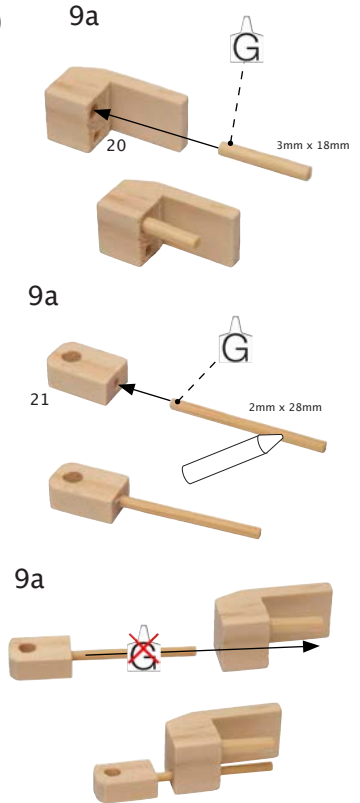

10

10a

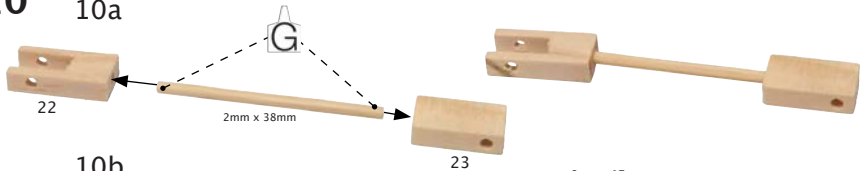

10b

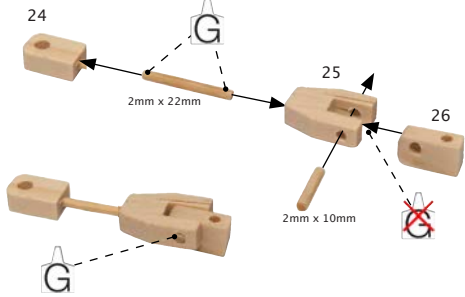

2mm x 17mm

10c

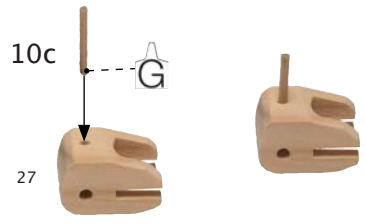

11

11a

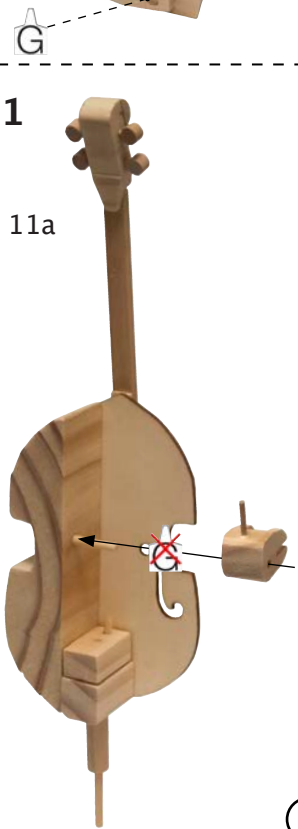

11b

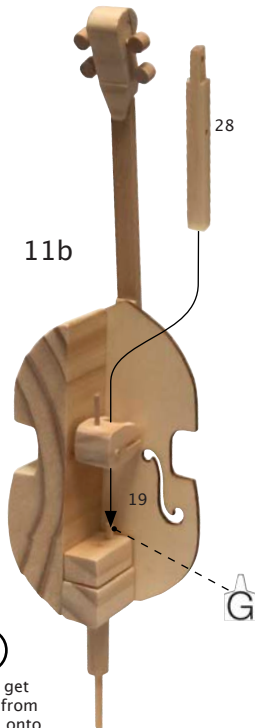

11c

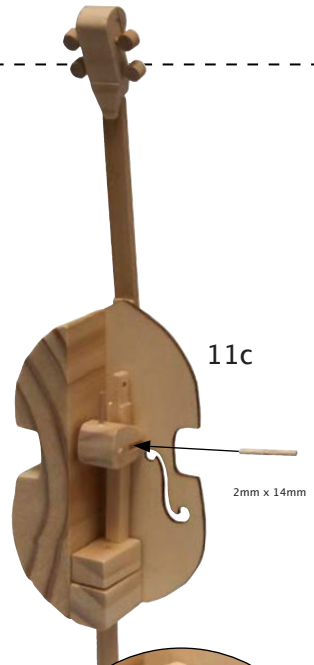

⚠
Do not get
glue on from
part #28 onto
part #19

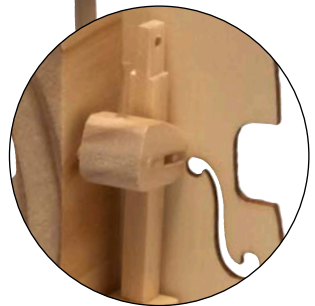

12

12c

12a

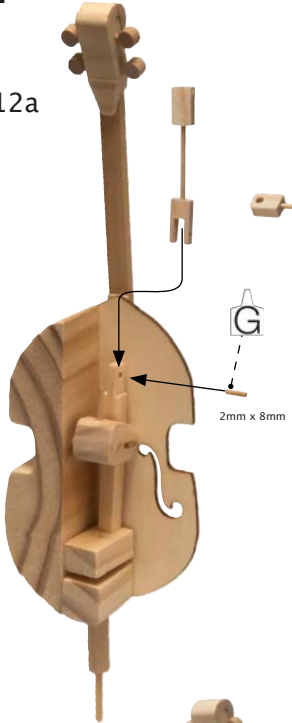

12b

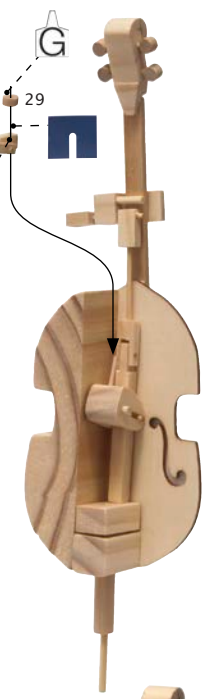

12d

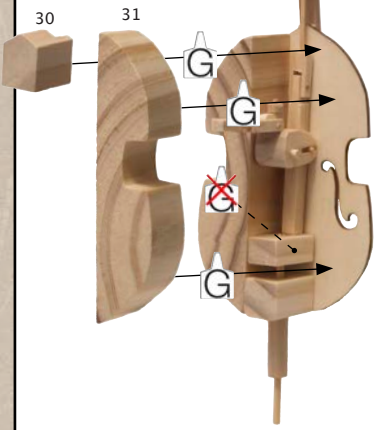

12e

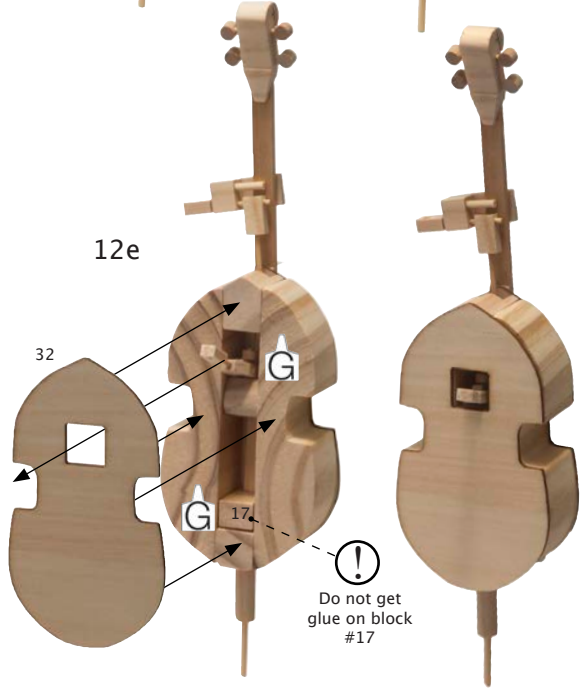

13

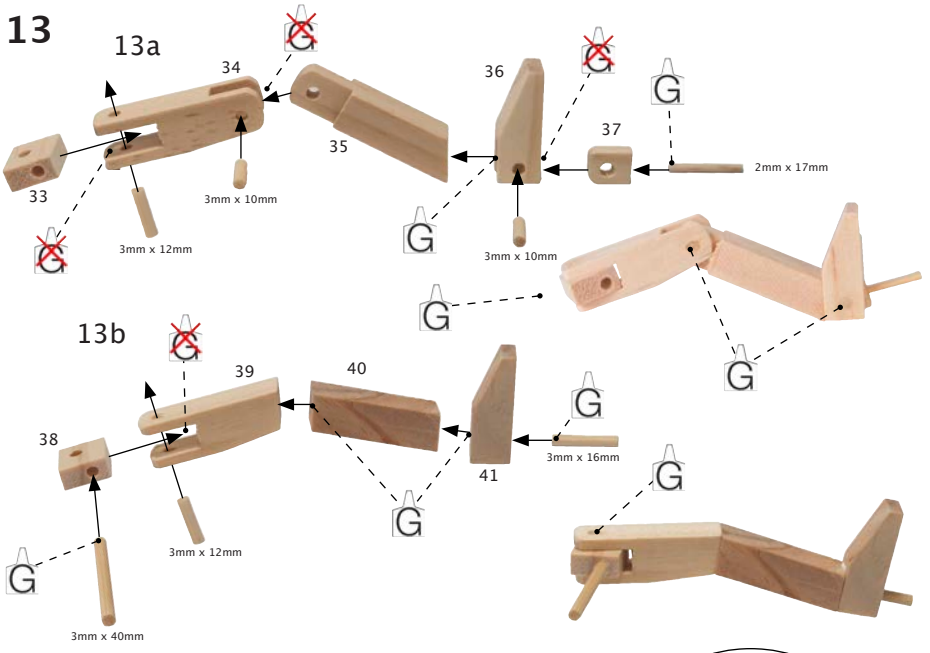

14

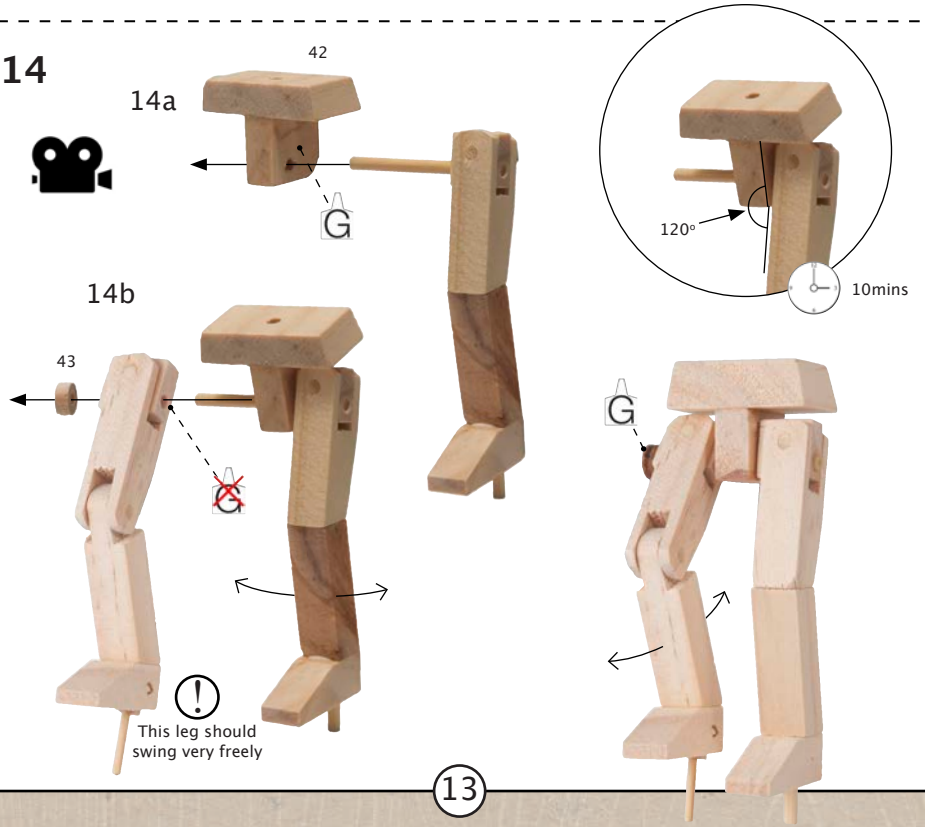

15

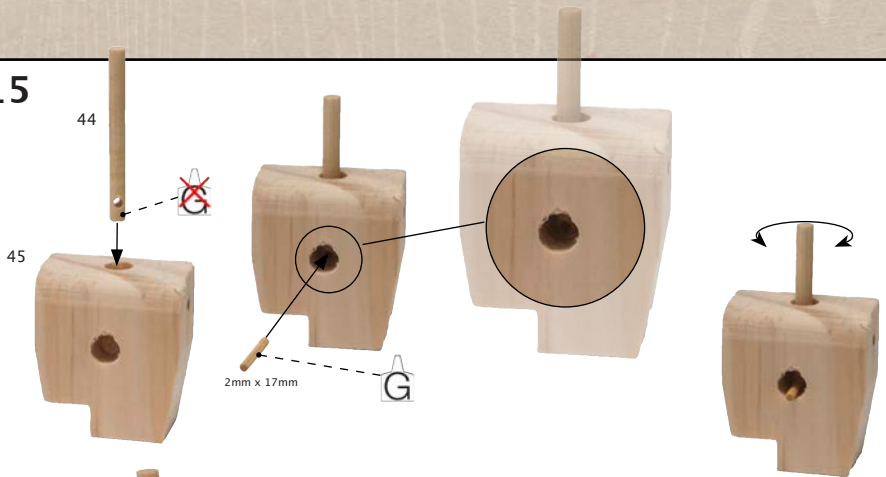

16

16a

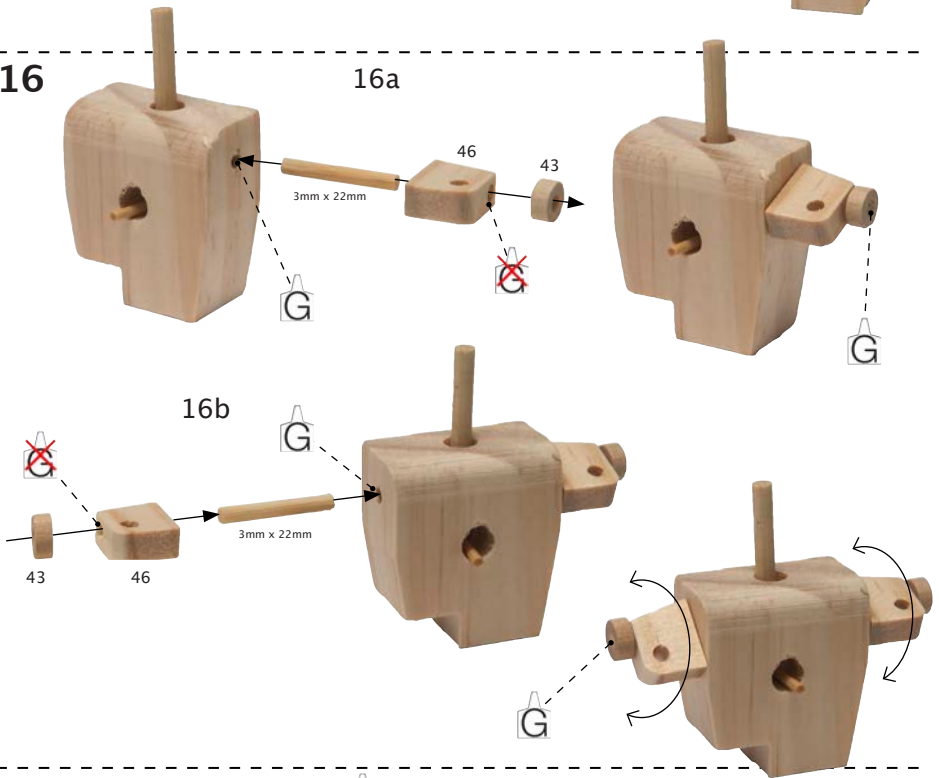

16b

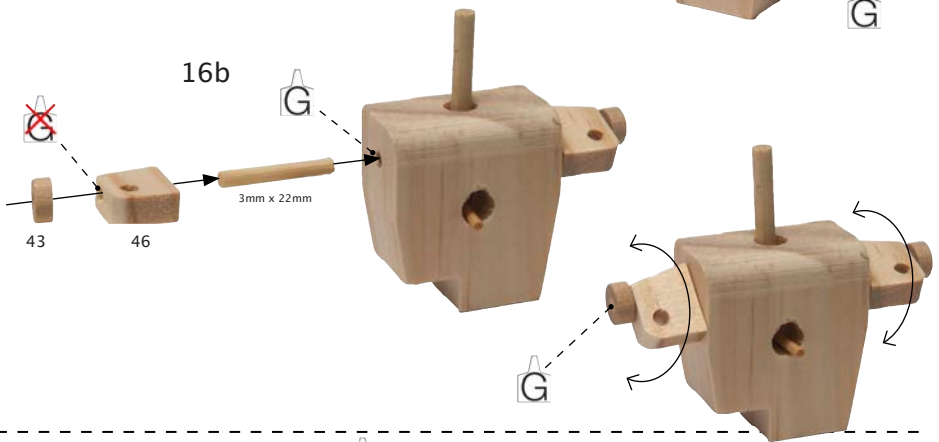

17

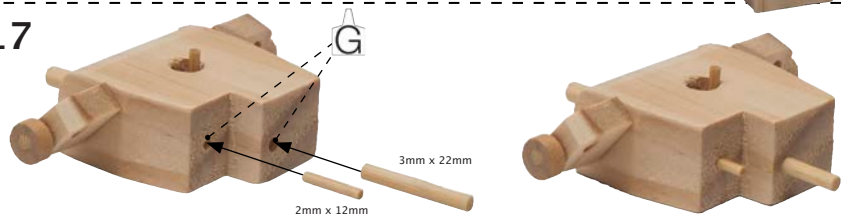

18

18a

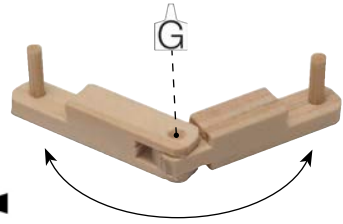
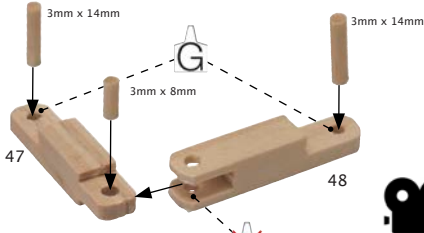

18b

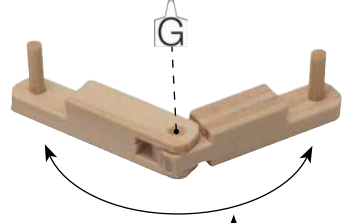
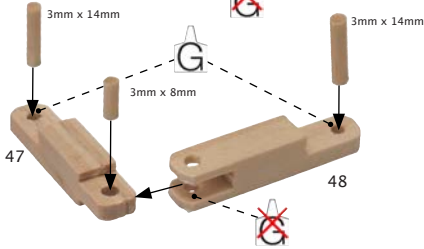

19

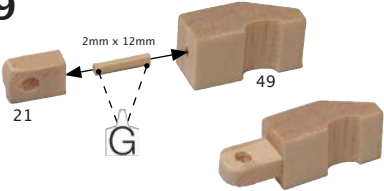

20

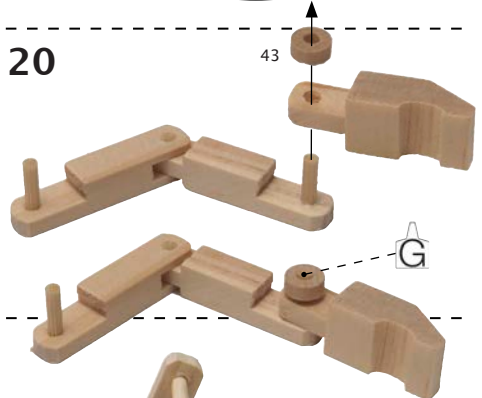

21

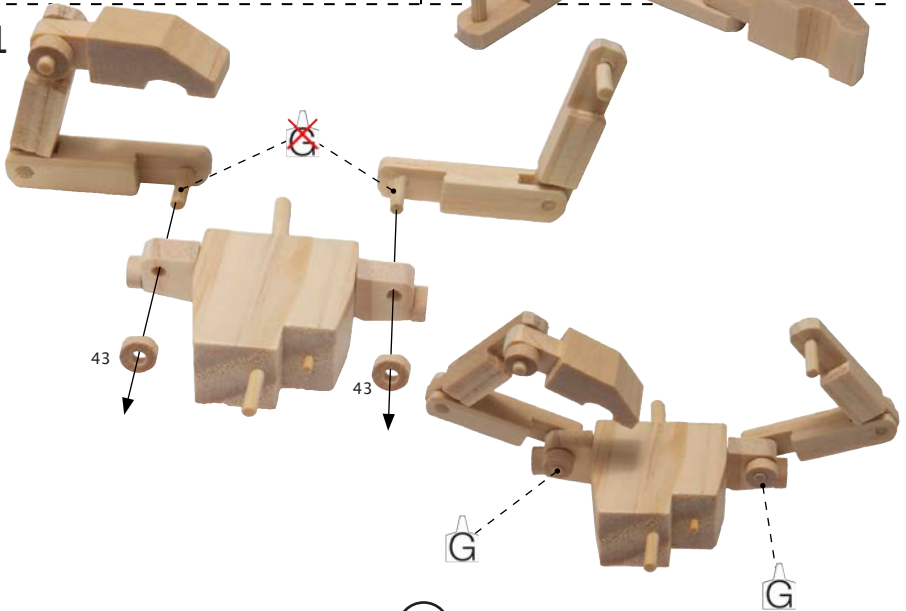

22

22a

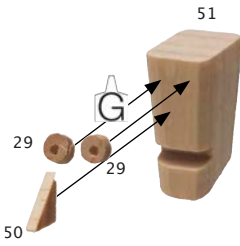

22b

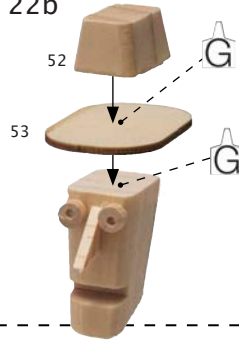

23

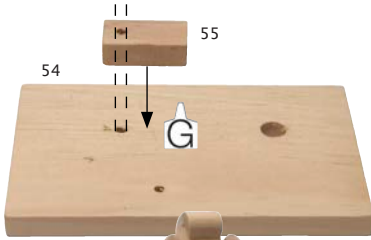

24



! See page 17 for details

24 cont.



20mins

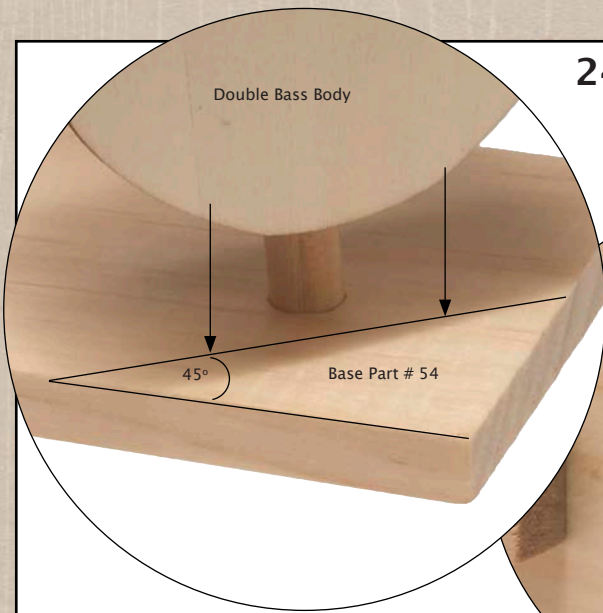

25



15mins



26

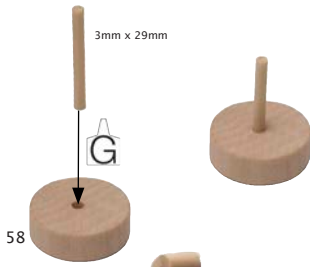

27

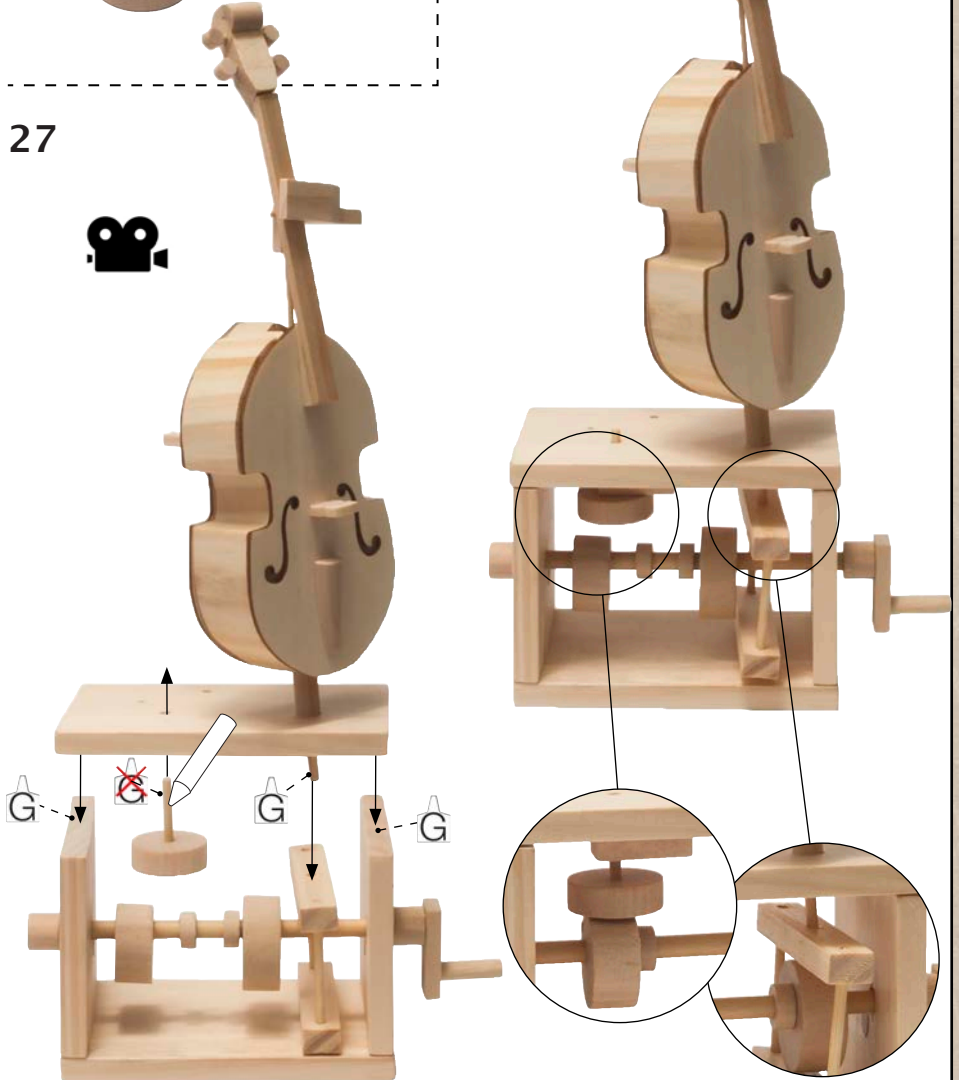

28

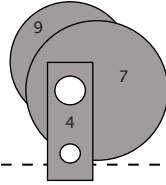
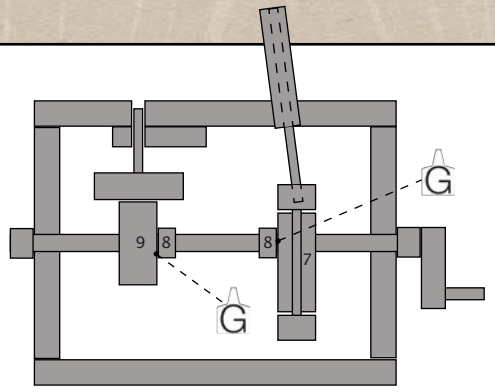
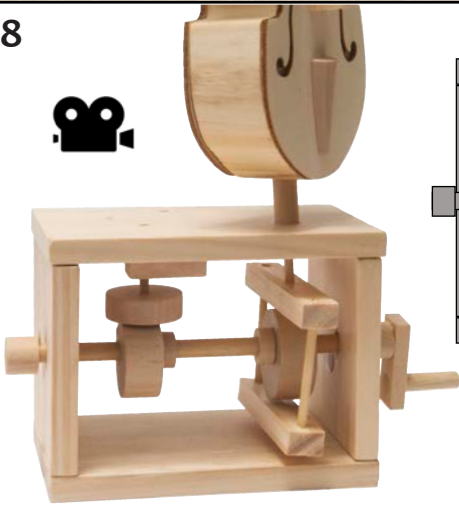

29

29a

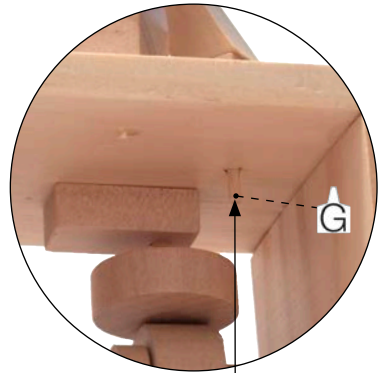
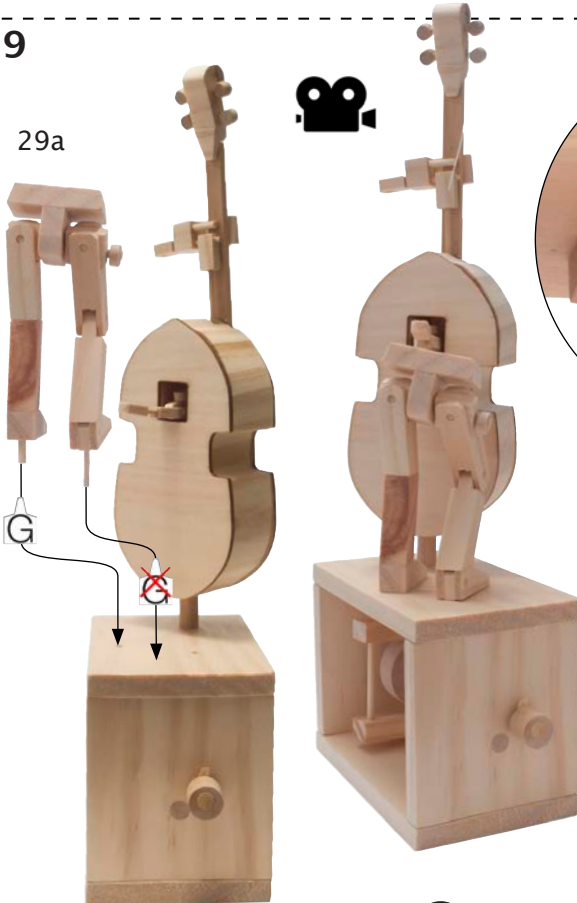

29b

59

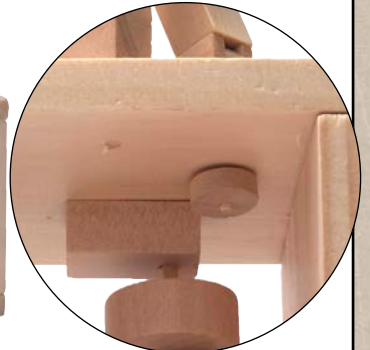

26

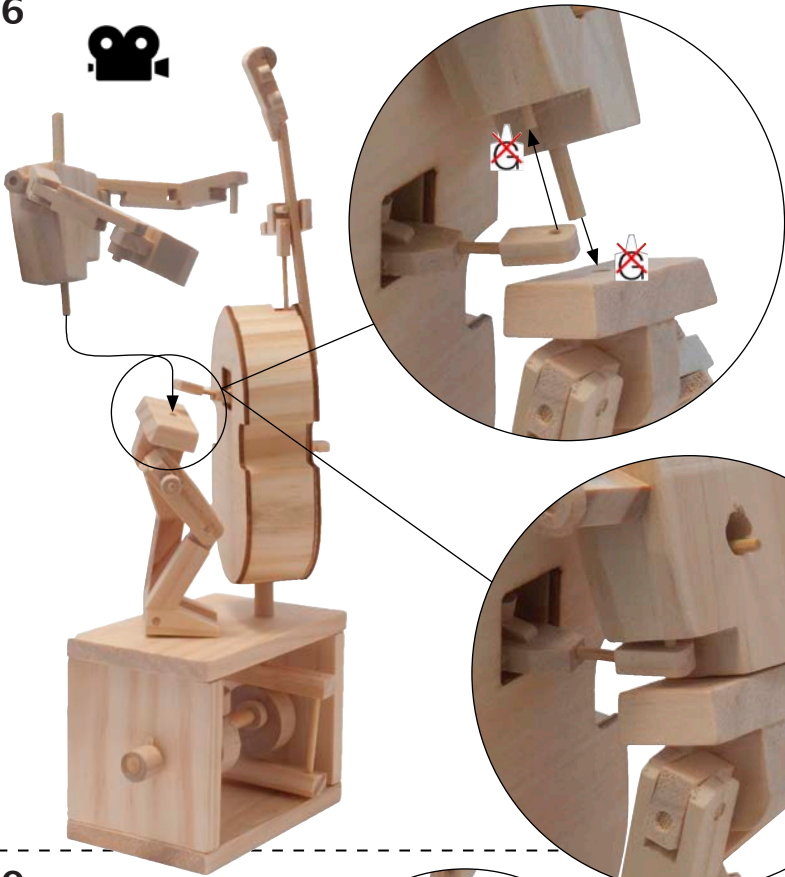

29

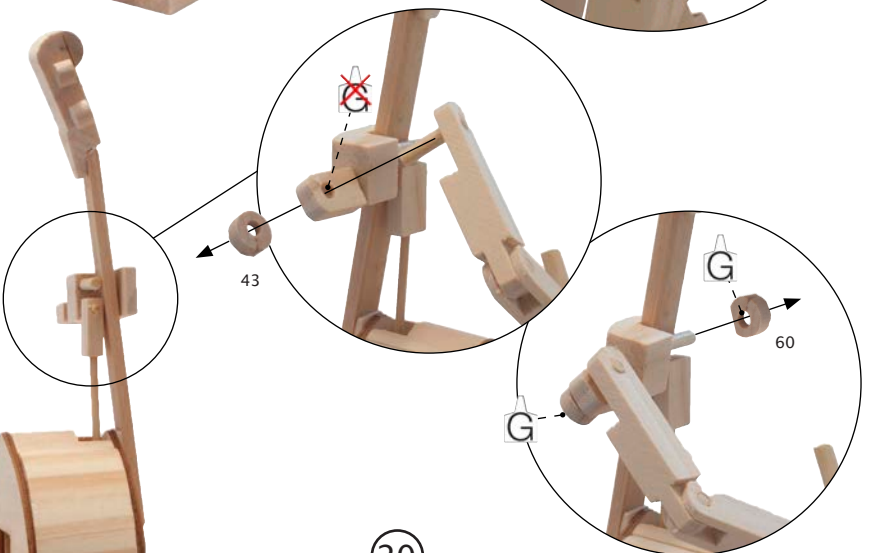

29



29



G

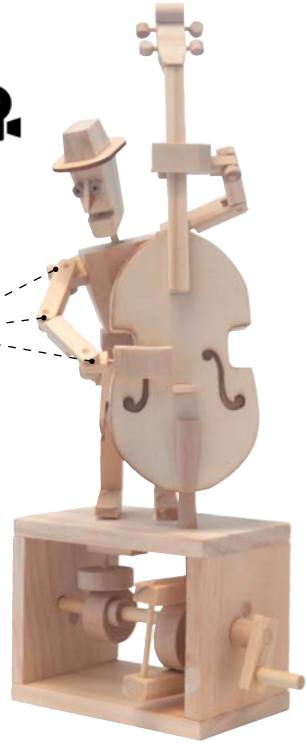

Notes

- (UK) If you enjoyed building this model why not try our others. Available directly from Timberkits Ltd or from our UK, European or worldwide retail partners. Check our website to find your nearest stockist.
- (FR) Si vous avez apprécié construire ce modèle, pourquoi ne pas en essayer d'autres. Ils sont disponibles chez Timberkits Ltd ou chez nos partenaires détaillants au Royaume Uni, en Europe et plus largement dans le monde.
- (SP) Si te has divertido con este modelo, porque no pruebas los ademas. Estan todos disponibles directamente desde Timberkit Ltd o desde las nuestra tiendas en Reino Unido, Europa o en otros continentes. Visita el nuestro sitio web para conocer el punto vendita mas cercano.
- (IT) Se ti sei entusiasmato a costruire questo modello, perche non provare gli altri. Sono disponibili direttamente dalla Timberkits Ltd oppure dai nostri rivenditori in Gran Bretagna, Europa e altri continenti. Visita il nostro sito web per trovare il più vicino punto vendita.
- (DE) Wenn sie freude daran hatten, dieses modell zu bauen, wieso nicht die anderen ausprobieren. Sie können direkt bei Timberkits Ltd bestellen oder bei unseren handelspartnern in Großbritannien, Europa und weltweit. Besuchen sie unsere webseite für ihren nächstgelegenen händ-ler.

www.timberkits.com





Timberkits Limited
Old Village Hall
Llanbrynmair
Powys, SY19 7AA
00 (44) (0) 1650 521635
timber_kits@btconnect.com
www.timberkits.com

Timberkits logo and all Timberkits designs are Copyright (©) 2012 all rights reserved.

